

# CASCOS

LIFTING PROFESSIONALS



## 4 POST LIFTS

# MOT ATL 5 Tn.

# C-451 C-455 CLASS VII



Model	Ref.	kg	Kg.	H. min.	V. Kw.	40"
C-451 MOT ATL	13.355A	5.000 Kg.	1.500 Kg.	180 mm.	400/230 V. 3 Kw.	40"
C-455 MOT ATL	13.354A	5.000 Kg.	1.600 Kg.	180 mm.	400/230 V. 3 Kw.	40"

### MOT ATL (CLASS VII) LIFT 5325 mm platform

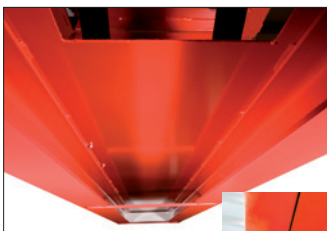

#### Extra reinforced platforms

Double T steel beams reinforce our platforms and **guarantee a perfect levelling over the years.**



Hydraulic Cylinders manufactured internally and 100% tested before assembly.

**Warranty 5 YEARS**  
Hydraulic

SEE CONDITIONS

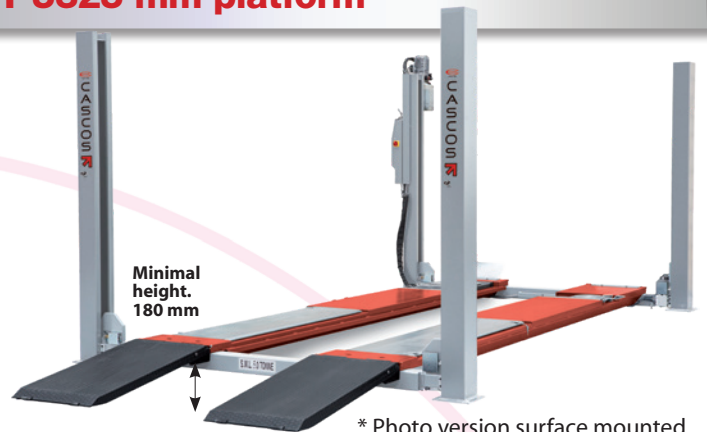

Minimal height. 180 mm

\* Photo version surface mounted.

#### Alerts

**Indicator** that prevents a bad levelling, and ensures that the cylinder works within the best conditions assuring a **longer lasting life.**



#### New luxury control box.

- Totally steel construction.
- Durable design.
- Integrates all the electronics and control of the lift and the play detector.
- Simple and reliable design.
- One single specially designed hydraulic power unit controls the main lift and the play detector.
- Motor and pump placed on top of the post, reducing space constraints.



Wired control lamp

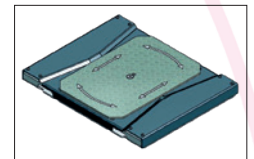

Hydraulic play detector

Lift includes play detector listed on VOSA accepted equipment, securely integrated on the platform designed with recesses to integrate turning plates and fix them in line with VOSA requirements.



In case of irregular floors, the lift can be levelled at 4 points.

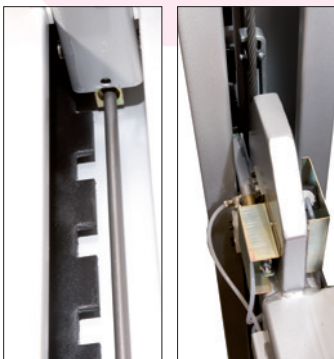

#### Security x2

Double system of security, **mechanical** (ladders and safety bars) and **pneumatic** that ensures a better reliability than the electro-magnetics systems.

Platform width adjustable in 4 positions.

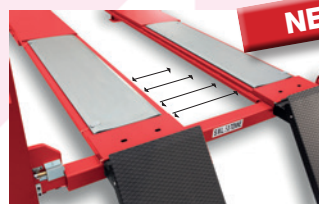

**NEW!**

#### Alignment plates.

New-design alignment platforms working on nylon rollers provide maximum precision and versatility for advanced alignment procedures.

CASCOS

RWTUV



2006/42/CE & EN-1493:2011  
European Directives & Approved Standards



After-Sales Quality & Service prize

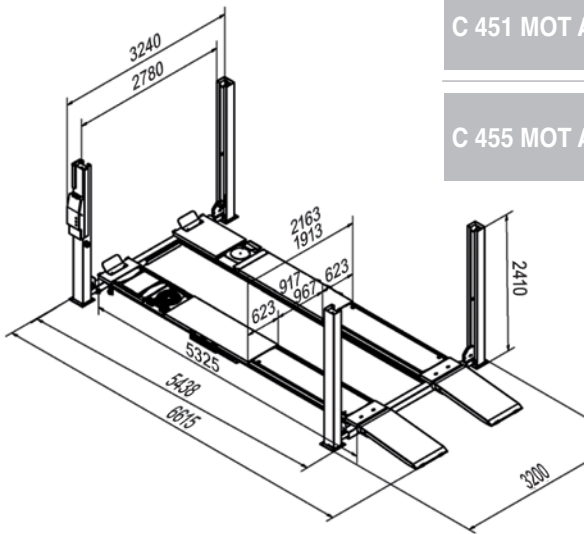

Mod.	Ref.
C 451 MOT ATL	13.355A
C 455 MOT ATL	13.354A

Flat platform with front recessed and play detector

Alignment platform with front recessed and play detector.

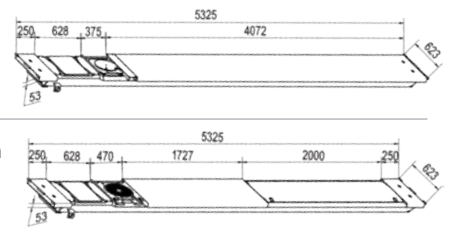

Recesses ready for alignment plates and / or turning plates 50 mm height. The lift includes Steel spacers for smaller turning plates.

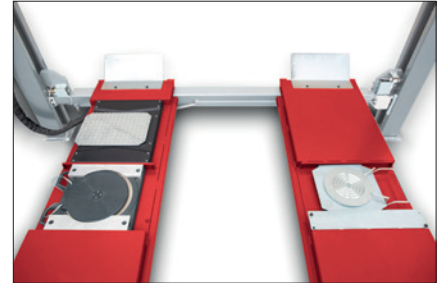

## Options

### Jacking beams



\* IMPORTANT:  
C-451/455 MOT ATL  
requires support Ref. 50513

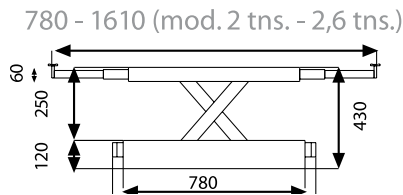

TWO TYPES \*:

- Manual:  
2 T Ref.: 50557  
2,6 T Ref.: 50559
- Automatic (pneumatic) driven motor/pump  
2 T Ref.: 50515  
2,6 T Ref.: 50517

### Turning plates

Ref.: 34275AC

Set of 50 mm. height turning plates.



### Surface mounted ramps

Ref.: 34752\_DH

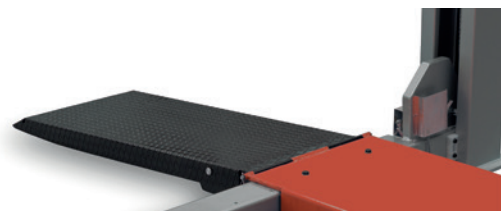

## Accessories

#### Magnetic lighting kit

Without installation



Ref.: 34053 LED 24 V

#### Magnetic holder for tools



#### Magnetic air Kit

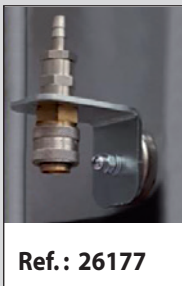

Ref.: 26177

#### Top Covers



Ref.: 32129  
C - 440/42/  
43/45/50/55

#### Recessed ramp

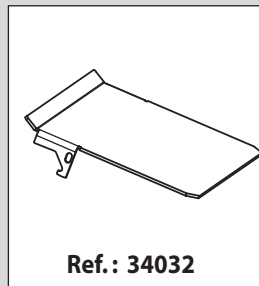

Ref.: 34032

#### Integrated power plug Assembled in factory



Ref.: 22164