



DOBLE TIJERAS

DOUBLE SCISSORS LIFT

PONT ÉLÉVATEUR À DOUBLE CISEAUX  
PRISE SOUS COQUE

# CASCOS



FABRICANTE EUROPEO DE ELEVADORES • EUROPEAN CAR LIFT MANUFACTURER • FABRICANT EUROPÉEN DE PONTS ÉLÉVATEURS



# Encastrado Onground Encastré

## DT 3600 E

## 3.6 Tn

Ref. 13165  
ENCASTRADO  
INGROUND  
ENCASTRÉ



**Elevador reversible.**  
*Lift reversible.*  
Pont réversible.



**Sentido de carga recomendado.**  
*Recommandable run direction.*  
Sens d'entrée recommandé



**Seguridad neumática-mecánica e hidráulica.**  
*Pneumatic-mechanical and hydraulic securities.*  
Sécurité pneumatique-mécanique et hydraulique.



**Longitud máxima con extensible 2.110 mm.**  
*Maximum length with extensible 2.110 mm.*  
Longueur avec l'extensible 2.110 mm.

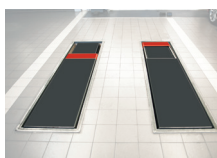

**Sistema eléctrico simplificado y fiable.**  
*Simplified and reliable electric system.*  
Système électrique simplifié et fiable.

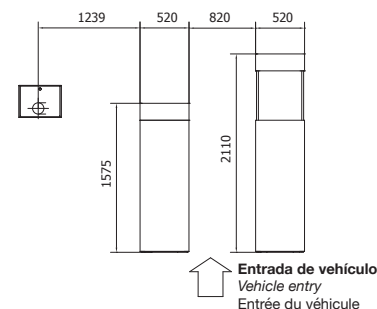
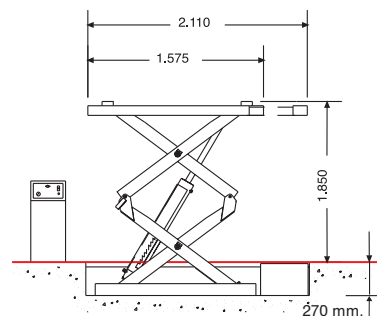

	<b>3.600</b>
	230/400/3 kW/50Hz
	875 Kg
	6 - 8 bar



**Kit variador:** Transforma elevador trifásico 380V en elevador monofásico a 220V.

El elevador mantiene su capacidad de elevación íntegra.

**Variator kit:** Transforms a 3Ph-380V lift into a 1Ph-220V.

The lift maintains its full lifting capacity.

**Kit variateur:** Transforme un pont triphasé en un autre monophasé à 220V.

Le pont maintient sa capacité de levage initiale.



**Estructura y base muy robusta de lanta maciza.**  
*Very solid structure and base "solid profiles".*  
Structure et embase très robuste "profilés pleins".

**Cilindros hidráulicos de gran dimensión que trabajan a menor presión.**  
*Great diameter hydraulic cylinders that work on lower pressure.*  
Vérins hydrauliques de grande dimension qui travaillent en plus basse pression.

**Fotocélula protegida integrada en la tijera.**  
*Protected photocell integrated on the scissor.*  
Photocellule protégée et intégrée dans le ciseau.

**Cilindros fabricados y controlados uno a uno en nuestra fábrica.**  
*Cylinders manufactured and tested one by one in our factory.*  
Vérins fabriqués et testés unitairement en notre usine.

## Accesorios / Accessories / Accessoires

## DT 3600 E • EVO II • EVO IIIR

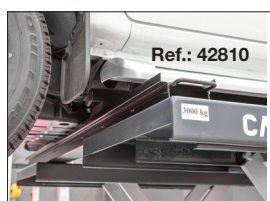

Ref.: 42810

**Opción: Kit de travesaños 4x4.**

**Option: 4x4 lifting bars.**

Option: traveses de levage 4x4.

Tacos de goma. / Rubber pads / Tampons caoutchouc



Ref.: 51001  
30 mm.

Ref.: 51002  
70 mm.

Ref.: 51003  
100 mm.

**Soporte magnético para herramientas**  
*Magnetic holder for tools*  
Porte-outils magnétique



Ref.: 26141

**Kit magnético de aire**  
*Magnetic air Kit*  
Connecteur d'air magnétique

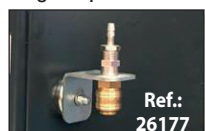

Ref.: 26177

**Kit de latiguillos**  
*Hose kit.*  
Kit de flexibles.



**Se suministran con consola a la izquierda.**  
**Existen kits para cambiar la ubicación de la consola o prolongar las distancias de serie:**  
DT 3600E 1,2 m. / EVO II-EVO IIIR 2 m.  
(Según el sentido de la marcha recomendado)

*Supplied with console to the left.*  
*Available kits to change the location of the console or extend standard distances:*  
DT 3600E 1.2m / EVO II-EVO IIIR 2m  
(According to the recommended run direction)

Pupitre positionné à gauche, de série.  
Des kits sont disponibles pour modifier l'emplacement du pupitre ou prolonger la distance de série:  
DT 3600E 1.2m / EVO II-EVO IIIR 2m (Selon le sens d'entrée préconisé)

**Accesorio rampas / Ramps accessorie / Accessoire rampes**  
Ref.: 42739 Ref.: 42709  
Entrada-parada/Run-in-Stop/Entrée butée Entrada-salida/Run-in/Run-out/Entrée-sortie

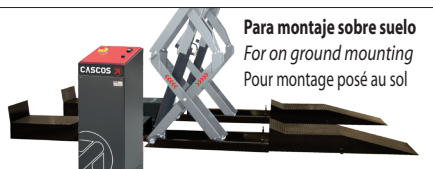

**Sobre suelo o encastrado**  
**Onground or inground**  
**Posé au sol ou encastré**

**EVO II**

**3 Tn** H. min. 105 mm.

**Ref. 13164 + 44730**

Versión sobre suelo  
 Onground version  
 Version posée au sol

**Ref. 13164 + 44731**

Versión encastrada  
 Inground version  
 Version encastrée



**2** **Sentido de carga recomendado.**  
*Recommandable run direction.*  
 Sens d'entrée recommandé.

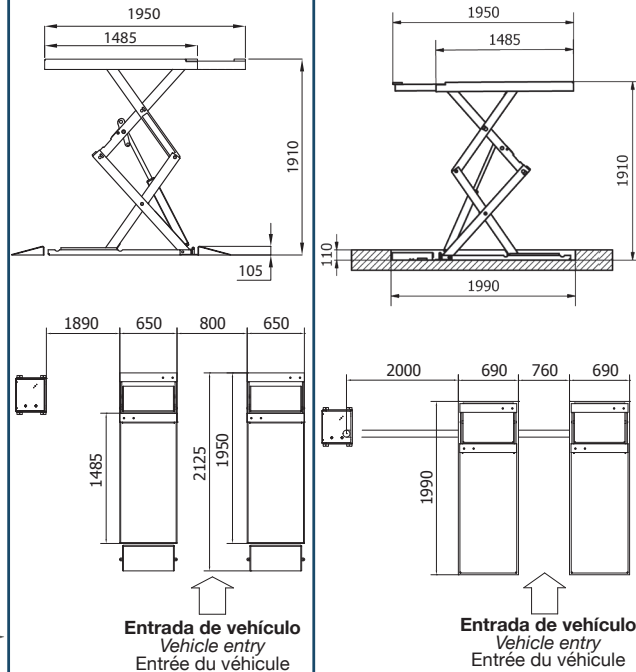

	<b>3.000</b>
	230/400/50Hz (Op.220/1Ph)
	800 Kg
	105 mm



**Extensible deslizante integrado en pasarela. EVO II.**  
*Sliding extension integrated on platforms. EVO II.*

Extensible coulissant intégré au Plateau. EVO II.



**Rampas de acceso siempre fijas en el suelo.**

*Access ramps always fixed to the floor.*

Rampes d'accès toujours fixées au sol.

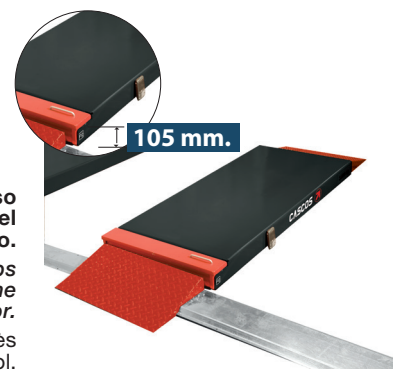

**Características comunes / Common features / Ca**

- **Doble seguridad hidráulica (dos juegos independientes maestro-esclavo cruzados en el elevador). No precisa de aire comprimido.**  
*Double hydraulic security (double crossed master-slave circuit) Compressed air no needed.*  
 Double sécurité hydraulique (double circuit maître+esclave croisé). Pas d'air comprimé exigé.

- **Estructura y base muy robusta de llanta maciza.**  
*Very solid structure and base "solid profiles".*  
 Structure et embase très robuste "profilés pleins".

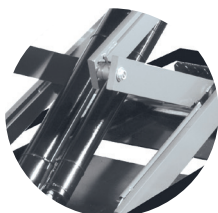

- **Purgado automático mediante botón.**  
*Automatic air bleeding by button.*  
 Purge automatique par bouton.



**Kit variador:** Transforma elevador trifásico 380V en elevador monofásico a 220V.

El elevador mantiene su capacidad de elevación íntegra.

**Variator kit:** Transforms a 3Ph-380V lift into a 1Ph-220V. The lift maintains its full lifting capacity.

**Kit variateur:** Transforme un pont triphasé en un autre monophasé à 220V.

Le pont maintient sa capacité de levage initiale.

- **Cilindros fabricados y controlados uno a uno en nuestra fábrica**  
*Cylinders manufactured and tested one by one in our factory.*  
 Vérins fabriqués et testés unitairement en notre usine.

- **Sistema eléctrico simplificado y fiable.**  
*Simplified and reliable electric system.*  
 Système électrique simplifié et fiable.

- **Altura mínima 105 mm.**  
*Minimum height 105 mm.*  
 Hauteur minimale 105 mm.

**Sobre suelo o encastrado**  
**Onground or inground**  
**Posé au sol ou encastré**

**EVO III R**

**3 Tn** H. min. 105 mm.

**Ref. 13203**  
 Versión sobre suelo  
 Ongoing version  
 Version posée au sol

**Ref. 13203 + 44630**  
 Versión encastrada  
 Inground version  
 Version encastrée



2

**Sentido de carga recomendado.**  
*Recomendable run direction.*  
 Sens d'entrée recommandé

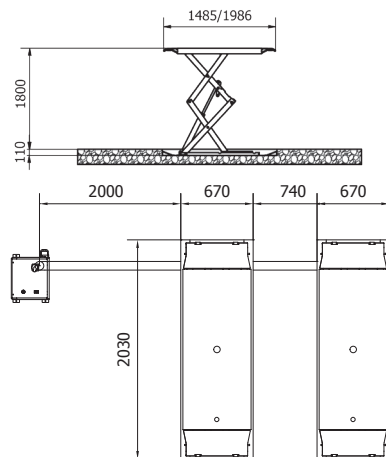
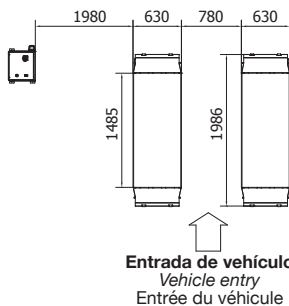
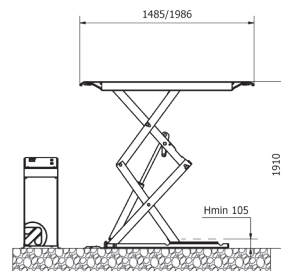

**Entrada de vehículo**  
*Vehicle entry*  
 Entrée du véhicule

**Kit de contra-rampas para versión encastrada.**  
*Contra-ramps kit for inground version*  
 Kit de contre-rampes pour version encastrée.

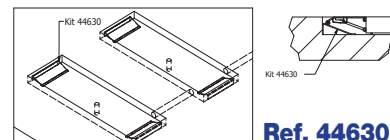

**Ref. 44630**

	<b>3.000</b>
	230/400/50Hz (Op.220/1Ph)
	800 Kg
	105 mm

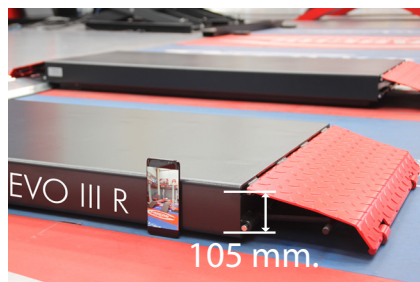

**Perfil bajo.**  
 Altura mínima 105 mm.  
*Low profile.*  
 Minimum height 105 mm.  
 Profil bas.  
 Hauteur minimale 105 mm.



\* **DIFERENCIAS / DIFFERENCES / DIFFÉRENCES: EVO II / EVO III R**

1

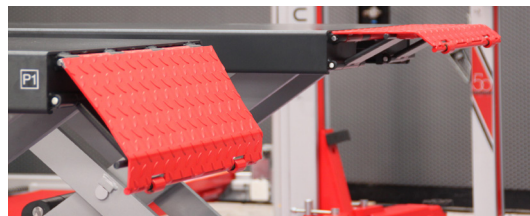

**Las rampas de acceso acompañan al elevador en la subida y funcionan como extensibles.**

*The access ramps accompany the elevator on the climb and function as extendable.*

Les rampes d'accès accompagnent le pont à la montée et fonctionnent comme des extensibles.

**Características comunes**

**EVO II • EVO III R**

- **Reparabilidad garantizada por un mínimo de 10 años.**  
 Se asegurará el suministro de piezas durante este período de tiempo.  
*Repairable during at least 10 years.*  
 We ensure spare parts availability during at least this period.  
 Réparabilité garantie pour un minimum de 10 ans.  
 On assure la disponibilité de pièces détachées au moins pendant cette période de temps.
- **Elevador reversible en el sentido de la carga.**  
*Lift reversible.*  
 Pont reversible à la charge.



- **Doble sistema hidráulico cruzado maestro-esclavo (4 cilindros).**  
*Double crossed master-slave hydraulic system (4 cylinders).*  
 Double système hydraulique croisé (4 vérins).



Product Video

# Servicio de ruedas

## Tyre service lift

### Pont basse levée

# 3 Tn

Ref. 14967  
14967 Mono

**Talleres de neumáticos y carrocerías**  
**Tyre services & card body whorkshops**  
**Ateliers de service de pneus et carrosserie**

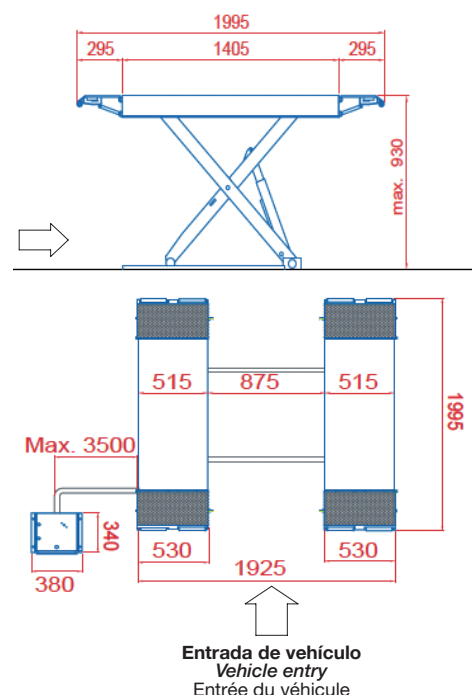

**Rápido, fiable y cómoda altura de trabajo.**

**Fast, reliable and comfortable working height.**

**Rapide, fiable avec une hauteur de travail pratique.**



**Altura mínima 95 mm.**  
**Minimum height 95 mm.**  
**Hauteur minimale de 95 mm.**

Ref.	14967	14967 Mono
	3.000	3.000
	400/3ph/50Hz	230/1ph/50Hz
	20"	35"
	500 Kg	500 Kg
	95 mm	95 mm



**Sistema hidráulico con 4 cilindros, mayor potencia.**

**4 cylinders hydraulic circuit, more powerful.**

**Système hydraulique à 4 vérins, plus puissante.**



**Pasarelas extensibles hasta 2.000 mm.**

**Extending platform up to 2.000 mm.**

**Plateaux extensible jusque 2.000 mm.**

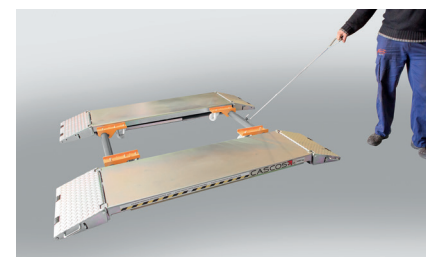

**Kit móvil opcional:**  
• Consola y plataformas sobre ruedas.

**Optional mobile Kit:**  
• Platforms and control box on wheels.

**Kit de movilidad en option:**  
• Boîtier de commande et passerelles sur roues.

- Válvula de control de bajada y sobrecarga.
- Señal acústica para descenso final.
- No precisa de aire comprimido.
- Doble circuito hidráulico cruzado independiente.
- 4 tacos de goma incluidos.

- Descend and overload control valve.
- Acoustic signal for final descent.
- Compressed air no needed.
- Double crossed hydraulic circuit.
- 4 rubber pads included.

- Valve de contrôle de descente et de surcharge.
- Signale sonore de descente finale.
- Pas besoin d'air comprimé.
- Double circuit hydraulique croisé.
- 4 tampons caoutchouc de série.

## Homologaciones / Approvals / Homologations



# CASCOS

[www.cascos.es](http://www.cascos.es)



### ESPAÑA

C/ Zurrupitieta, 8 / Pol. Ind. Júndiz  
Teléfono 945 290 294 / Fax 945 290 055  
Vitoria-Gasteiz (Spain)  
e-mail: [info@cascos.es](mailto:info@cascos.es)

### FRANCE

Cascos Lift France  
Phone + 33 781 170 361  
54000 Nancy (France)  
e-mail: [c.stein@cascos.es](mailto:c.stein@cascos.es)



2005/42/CE & EN - 1498:2011  
European Directives  
& Approved Standards



CASCOS MAQUINARIA SE RESERVA EL DERECHO DE REALIZAR MODIFICACIONES TÉCNICAS SIN PREVIO AVISO  
THE PLANS AND PHOTOGRAPHS SHOWN IN THIS BROCHURE ARE FOR ILLUSTRATIVE PURPOSES ONLY, AND CM RESERVES THE RIGHT FROM TIME TO TIME TO MAKE MODIFICATIONS.  
PHOTOS ET DESSINS NON CONTRACTUELS